

(平面図)

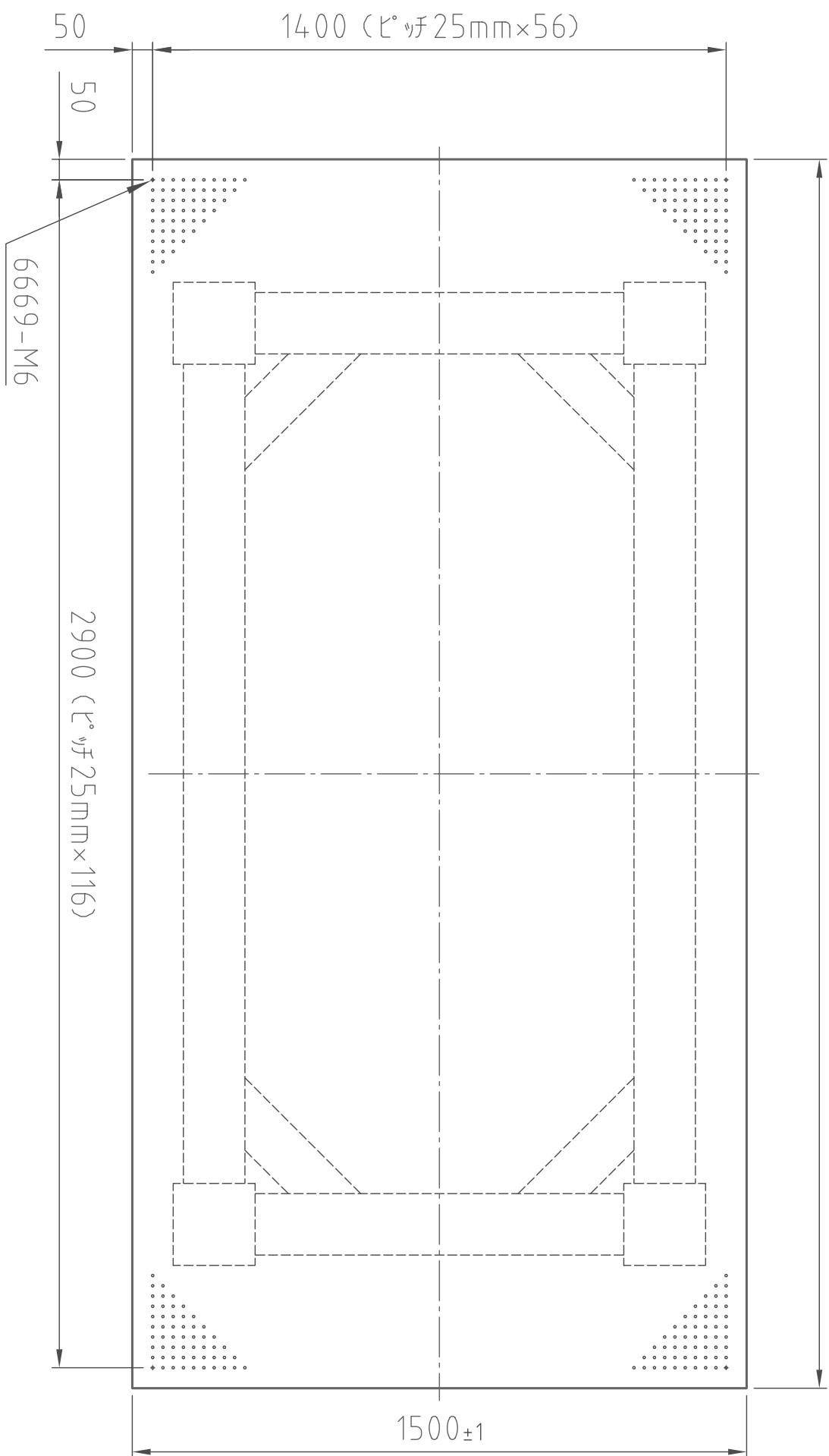

(正面図)

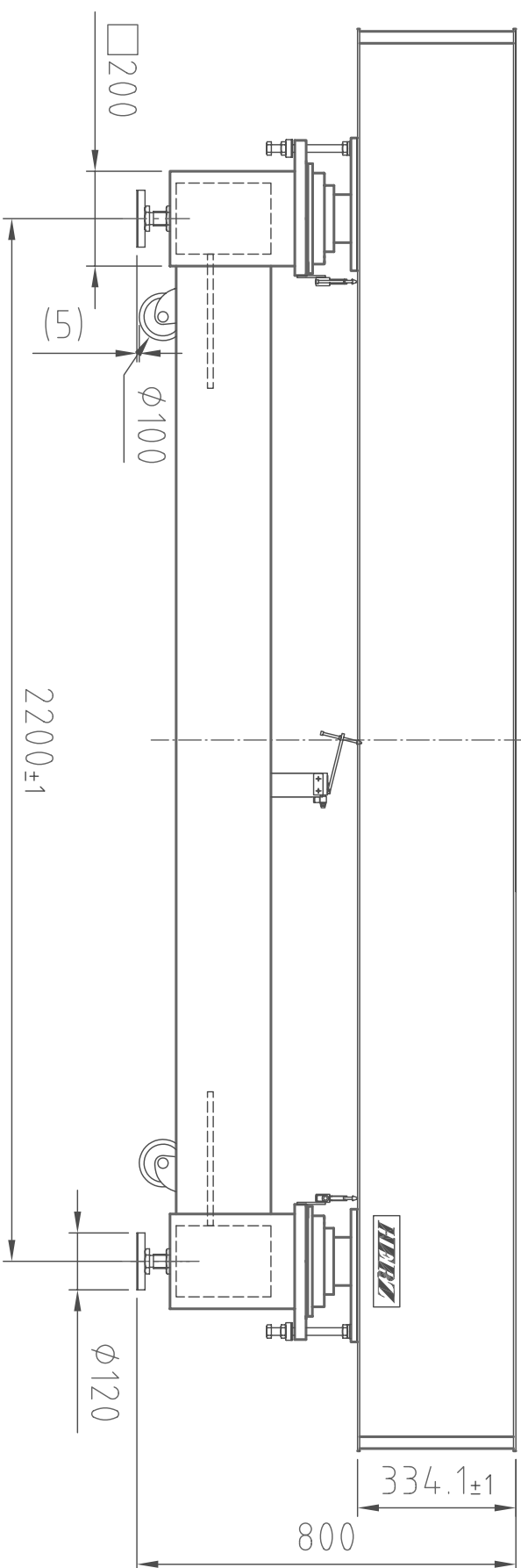

(右側面図)

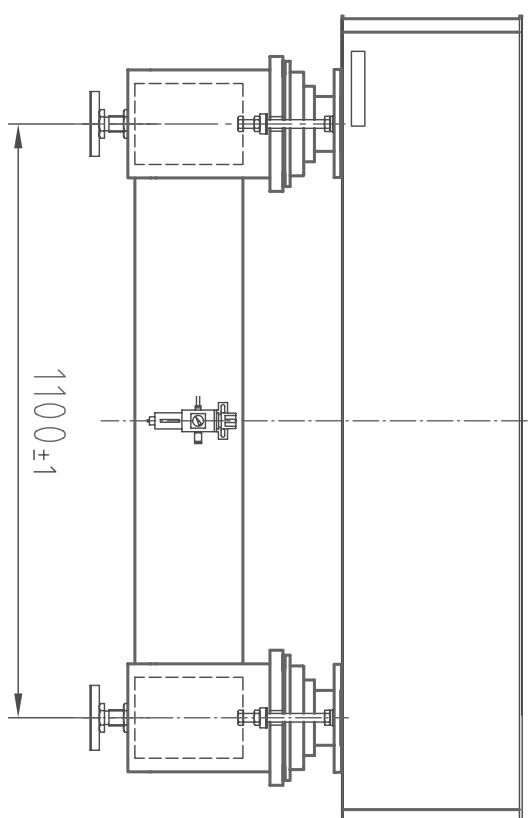

TDI-3015LA